

Silicon N-Channel Power MOSFET

General Description :

HMM80N90, the silicon N-channel Enhanced VDMOSFET, is obtained by the self-aligned planar Technology which reduce the conduction loss, improve switching performance and enhance the avalanche energy. The transistor can be used in various power switching circuit for system miniaturization and higher efficiency. The package form is Sot-227B, which accords with the RoHS standard.

Features :

- Fast Switching
- ESD Improved Capability
- Low Gate Charge
- Low Reverse transfer capacitances
- 100% Single Pulse avalanche energy Test

Applications:

- Power switch circuit of POWER

Absolute (Tc=25°C unless otherwise specified) :

Symbol	Parameter	Rating	Units
V _{DSS}	Drain-to-Source Voltage	900	V
I _D	Continuous Drain Current	80	A
	Continuous Drain Current T _C =100 °C	60	A
I _{DM} ^{a1}	Pulsed Drain Current(pulse width limited by T _{JM})	320	A
V _{GS}	Gate-to-Source Voltage	±40	V
E _{AS}	Single Pulse Avalanche Energy	4100	mJ
E _{AR} ^{a1}	Avalanche Energy ,Repetitive	80	mJ
I _{AR} ^{a1}	Avalanche Current	60	A
dv/dt ^{a2}	Peak Diode Recovery dv/dt	5.0	V/ns
P _D	Power Dissipation	700	W
	Derating Factor above 25°C	5.6	W/°C
T _J , T _{stg}	Operating Junction and Storage Temperature Range	150 , -55 to 150	°C
T _L	Maximum Temperature for Soldering	300	°C

Caution Stresses greater than those in the "Absolute Maximum Ratings" may cause permanent damage to the device

V _{DSS} (T _C =150°C)	900	V
I _D	80	A
P _D (T _C =25°C)	700	W
R _{DS(ON)MAX}	200	mΩ

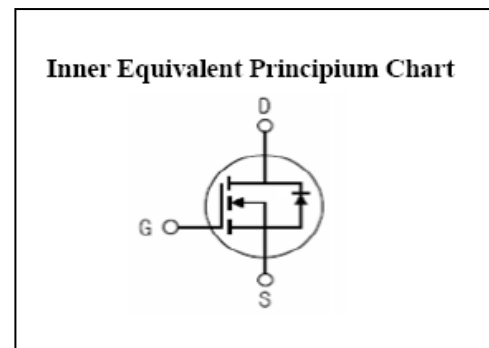
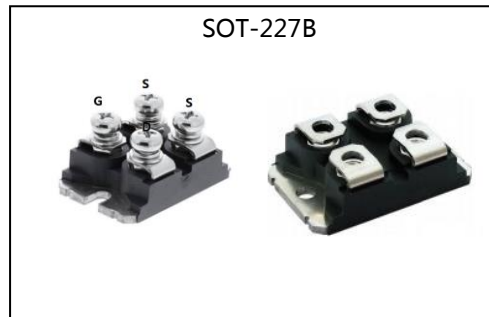

Thermal Characteristics

Symbol	Parameter	Rating	Units
R_{thJC}	Thermal Resistance, Junction-to-Case	0.179	°C/ W
R_{thcs}	Thermal Resistance, Case to heatsink	0.05	°C/ W

Electrical Characteristics ($T_c = 25^\circ\text{C}$ unless otherwise specified) :

OFF Characteristics						
Symbol	Parameter	Test Conditions	Rating			Units
			Min.	Typ.	Max.	
V_{DSS}	Drain to Source Breakdown Voltage	$V_{GS}=0V, I_D=250\mu A$	900	--	--	V
I_{DSS}	Drain to Source Leakage Current	$V_{DS}=900V, V_{GS}=0V, T_a=25^\circ\text{C}$	--	--	50	μA
		$V_{DS}=720V, V_{GS}=0V, T_a=125^\circ\text{C}$	--	--	3000	
$I_{GSS(F)}$	Gate to Source Forward Leakage	$V_{GS}=+30V$	--	--	200	nA
$I_{GSS(R)}$	Gate to Source Reverse Leakage	$V_{GS}=-30V$	--	--	-200	nA

ON Characteristics						
Symbol	Parameter	Test Conditions	Rating			Units
			Min.	Typ.	Max.	
$R_{DS(ON)}$	Drain-to-Source On-Resistance	$V_{GS}=10V, I_D=40A$	--	130	200	m Ω
$V_{GS(TH)}$	Gate Threshold Voltage	$V_{DS}=V_{GS}, I_D=8mA$	2.0	--	5.0	V
g_{fs}	Forward Trans conductance	$V_{DS}=15V, I_D=40A$	--	55	--	S

Pulse width < 380 μ s; duty cycle < 2%.

Dynamic Characteristics						
Symbol	Parameter	Test Conditions	Rating			Units
			Min.	Typ.	Max.	
C_{iss}	Input Capacitance	$V_{GS}=0V, V_{DS}=25V$ $f=1.0MHz$	--	15	--	nF
C_{oss}	Output Capacitance		--	1350	--	pF
C_{rss}	Reverse Transfer Capacitance		--	160	--	

Resistive Switching Characteristics						
Symbol	Parameter	Test Conditions	Rating			Units
			Min.	Typ.	Max.	
$t_{d(ON)}$	Turn-on Delay Time	$I_D=40A, V_{DD}=450V$ $V_{GS}=10V, R_g=25\Omega$	--	85	--	ns
t_r	Rise Time		--	100	--	
$t_{d(OFF)}$	Turn-Off Delay Time		--	150	--	
t_f	Fall Time		--	90	--	
Q_g	Total Gate Charge	$I_D=40A, V_{DD}=450V$ $V_{GS}=10V$	--	460	--	nC
Q_{gs}	Gate to Source Charge		--	150	--	
Q_{gd}	Gate to Drain ("Miller") Charge		--	120	--	

Source-Drain Diode Characteristics						
Symbol	Parameter	Test Conditions	Rating			Units
			Min.	Typ.	Max.	
I_{SD}	Continuous Source Current (Body Diode)		--	--	80	A
I_{SM}	Maximum Pulsed Current (Body Diode)		--	--	320	A
V_{SD}	Diode Forward Voltage	$I_S=80A, V_{GS}=0V$	--	--	1.5	V
t_{rr}	Reverse Recovery Time	$I_S=80A, T_j=25^\circ C$	--	489	--	ns
Q_{rr}	Reverse Recovery Charge	$dI_F/dt=100A/\mu s,$ $V_{GS}=0V$	--	2.5	--	μC

a1 : Repetitive rating; pulse width limited by maximum junction temperature

a2 : $I_{SD}=80A, di/dt \leq 100A/\mu s, V_{DD} \leq BV_{DS},$ Start $T_j=25^\circ C$

Characteristics Curve :

Fig. 1. Output Characteristics @ $T_J = 25^\circ\text{C}$

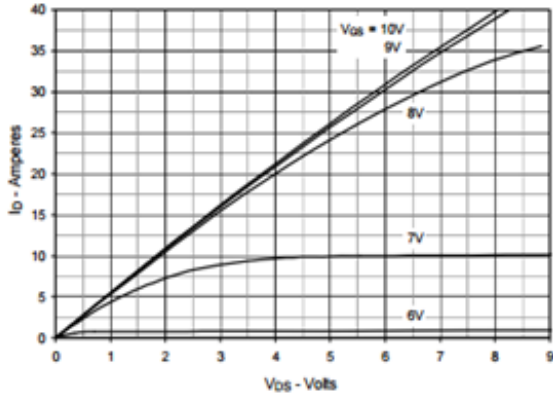

Fig. 2. Extended Output Characteristics @ $T_J = 25^\circ\text{C}$

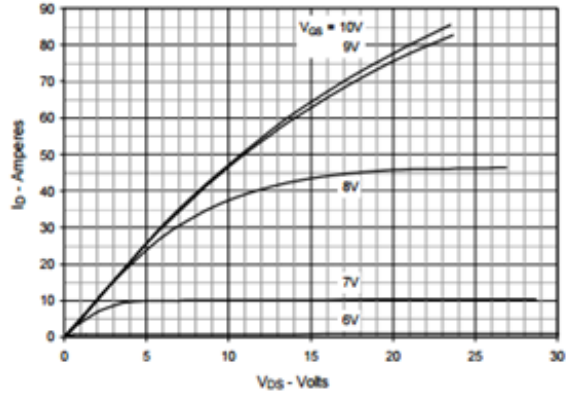

Fig. 3. Output Characteristics @ $T_J = 125^\circ\text{C}$

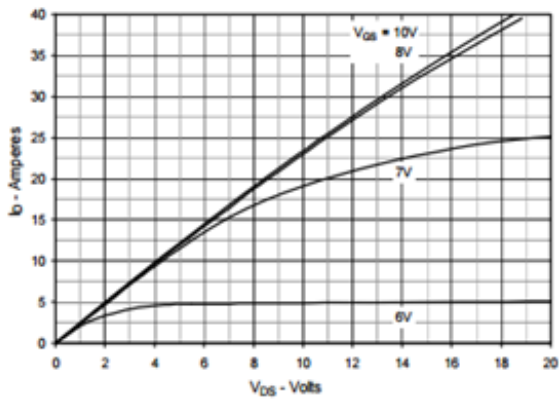

Fig. 4. $R_{DS(on)}$ Normalized to $I_D = 20\text{A}$ Value vs. Junction Temperature

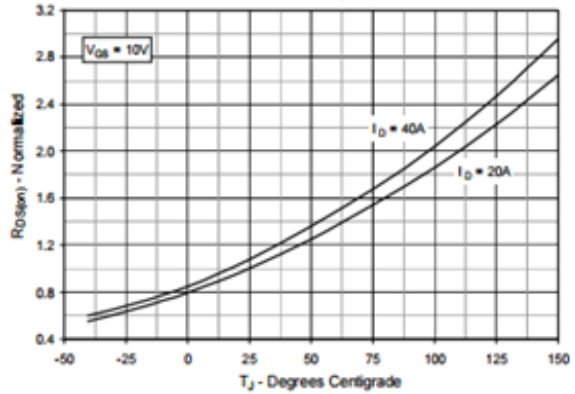

Fig. 5. $R_{DS(on)}$ Normalized to $I_D = 20\text{A}$ Value vs. Drain Current

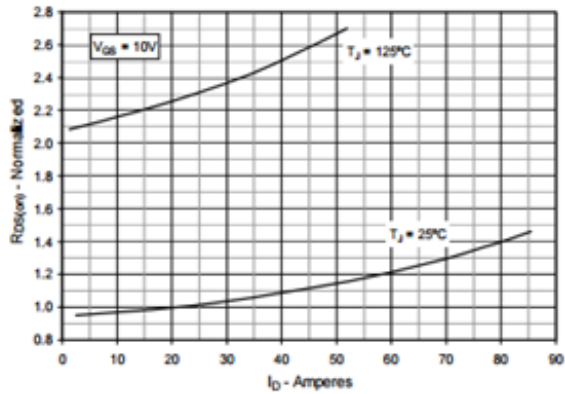

Fig. 6. Maximum Drain Current vs. Case Temperature

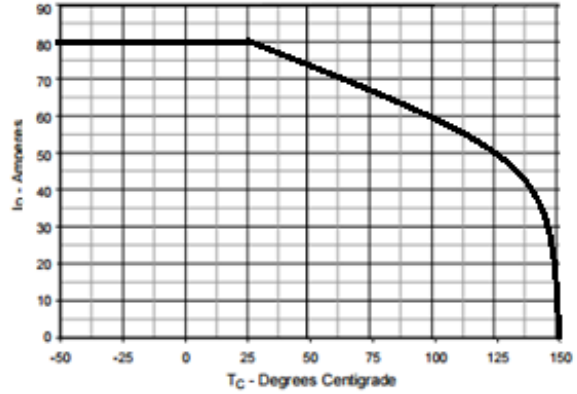

Fig. 7. Input Admittance

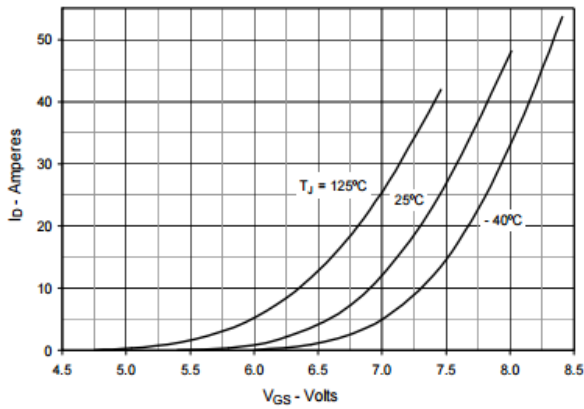

Fig. 8. Transconductance

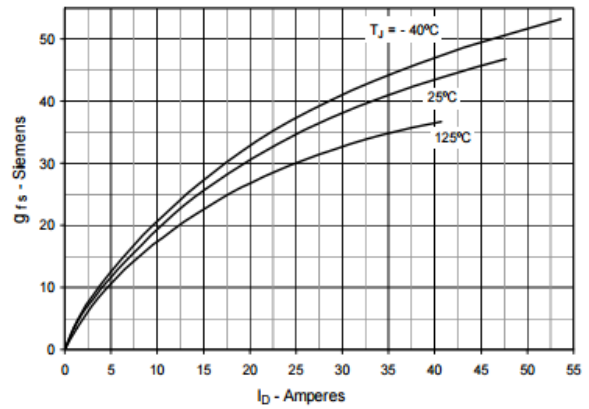

Fig. 9. Forward Voltage Drop of Intrinsic Diode

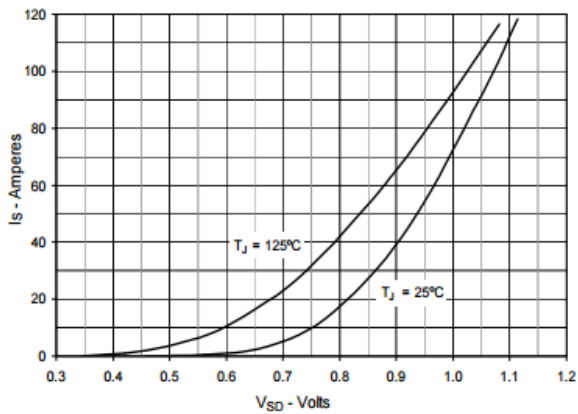

Fig. 10. Gate Charge

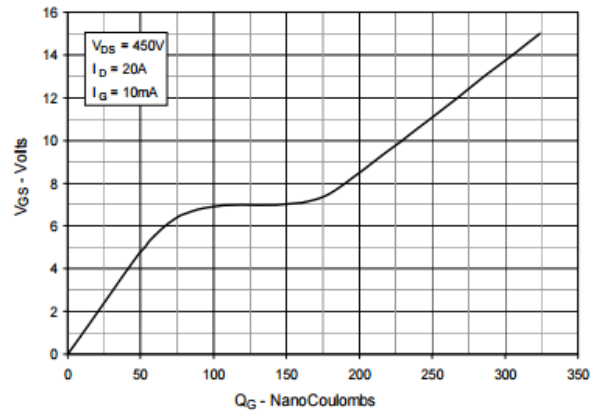

Fig. 11. Capacitance

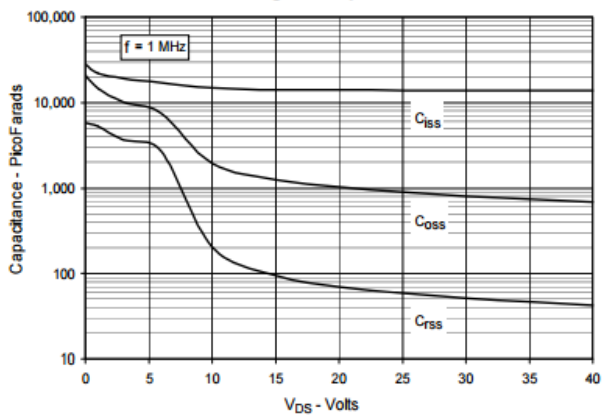

Fig. 12. Maximum Transient Thermal Impedance

