



HG40N120F1A1

1200V /40A Trench Field Stop IGBT

FEATURES

- High breakdown voltage to 1200V for improved reliability
- Trench-Stop Technology offering :
 - High speed switching
 - High ruggedness, temperature stable
 - Short circuit withstand time – 10 μ s
 - Low V_{CEsat}
 - Easy parallel switching capability due to positive temperature coefficient in V_{CEsat}
- Enhanced avalanche capability

| | | |
|-----------------------|------|---|
| V_{CE} | 1200 | V |
| I_C | 40 | A |
| $V_{CE(SAT)} I_C=40A$ | 2.0 | V |

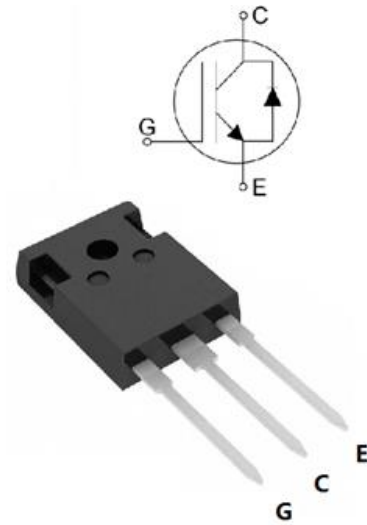

APPLICATION

- Uninterruptible Power Supplies
- Solar inverter
- Welding
- PFC applications

| | | |
|--------------|---------|-----------|
| Product | Package | Packaging |
| HG40N120F1A1 | TO247 | Tube |

Maximum Ratings

| Parameter | Symbol | Value | Unit |
|---|-------------|------------|------------------|
| Collector-Emitter Breakdown Voltage | V_{CE} | 1200 | V |
| DC collector current, limited by T_{jmax} $T_C = 25^\circ\text{C}$ $T_C = 100^\circ\text{C}$ | I_C | 80 40 | A |
| Diode Forward current, limited by T_{jmax} $T_C = 25^\circ\text{C}$ $T_C = 100^\circ\text{C}$ | I_F | 80 40 | A |
| Continuous Gate-emitter voltage | V_{GE} | ± 20 | V |
| Transient Gate-emitter voltage | V_{GE} | ± 30 | V |
| Turn off safe operating area $V_{CE} \leq 1200\text{V}$, $T_j \leq 150^\circ\text{C}$ | - | 160 | A |
| Pulsed Collector Current, $V_{GE} = 15\text{V}$, t_p limited by T_{jmax} | I_{CM} | 160 | A |
| Diode Pulsed Current, t_p limited by T_{jmax} | I_{Fpuls} | 160 | A |
| Short Circuit Withstand Time, $V_{GE} = 15\text{V}$, $V_{CE} \leq 600\text{V}$ | T_{sc} | 10 | μs |
| Power dissipation , $T_j = 25^\circ\text{C}$ | P_{tot} | 417 | W |
| Operating junction temperature | T_j | -40...+150 | $^\circ\text{C}$ |
| Storage temperature | T_s | -55...+150 | $^\circ\text{C}$ |
| Soldering temperature, wave soldering 1.6mm (0.063in.) from case for 10s | - | 260 | $^\circ\text{C}$ |

Thermal Resistance

| Parameter | Symbol | Max. Value | Unit |
|--|-------------------|------------|------|
| IGBT thermal resistance, junction - case | $R_{\theta(j-c)}$ | 0.3 | K/W |
| Diode thermal resistance, junction - case | $R_{\theta(j-c)}$ | 0.7 | K/W |
| Thermal resistance, junction - ambient | $R_{\theta(j-a)}$ | 40 | K/W |

Electrical Characteristics of the IGBT ($T_j = 25^\circ\text{C}$ unless otherwise specified) :

| Parameter | Symbol | Conditions | Min. | Typ. | Max. | Unit |
|--------------------------------------|---------------|--|--------|------------|------------|---------|
| Static | | | | | | |
| Collector-Emitter breakdown voltage | BV_{CES} | $V_{GE}=0V, I_C=250\mu A$ | 1200 | 1300 | - | V |
| Gate threshold voltage | $V_{GE(th)}$ | $V_{GE}=V_{CE}, I_C=250\mu A$ | 5.1 | 5.8 | 6.4 | V |
| Collector-Emitter Saturation voltage | $V_{CE(sat)}$ | $V_{GE}=15V, I_C=40A$ $T_j = 25^\circ\text{C}$ $T_j = 150^\circ\text{C}$ | - - | 2.0 2.5 | 2.5 - | V |
| Zero gate voltage collector current | I_{CES} | $V_{CE} = 1200V, V_{GE} = 0V$ $T_j = 25^\circ\text{C}$ $T_j = 150^\circ\text{C}$ | - - | - - | 10 2500 | μA |
| Gate-emitter leakage current | I_{GES} | $V_{CE} = 0V, V_{GE} = \pm 20V$ | - | - | 100 | nA |
| Transconductance | g_{fs} | $V_{CE}=20V, I_C=15A$ | - | 15 | - | S |

| Parameter | Symbol | Conditions | Min. | Typ. | Max. | Unit |
|---------------------------------|-------------|---|------|------|------|------|
| Dynamic | | | | | | |
| Input capacitance | C_{ies} | $V_{CE} = 25V, V_{GE} = 0V,$ $f = 1\text{MHz}$ | - | 4400 | - | pF |
| Output capacitance | C_{oes} | | - | 180 | - | |
| Reverse transfer capacitance | C_{res} | | - | 100 | - | |
| Gate charge | Q_G | $V_{CC} = 960V, I_C = 40A,$ $V_{GE} = 15V$ | - | 270 | - | nC |
| Short circuit collector current | $I_{C(SC)}$ | $V_{GE}=15V, t_{sc}\leq 10\mu s$ $V_{CC}=600V,$ $T_{j, start}=25^\circ\text{C}$ | - | 240 | - | A |

Switching Characteristic, Inductive Load

| Parameter | Symbol | Conditions | Min. | Typ. | Max. | Unit |
|--|--------------|---|------|------|------|------|
| Dynamic , at $T_j = 25^\circ \text{C}$ | | | | | | |
| Turn-on delay time | $t_{d(on)}$ | $V_{CC} = 600\text{V}, I_C = 40\text{A},$ $V_{GE} = 0/15\text{V},$ $R_g = 12\Omega$ | - | 60 | - | ns |
| Rise time | t_r | | - | 27 | - | ns |
| Turn-on energy | E_{on} | | - | 2.9 | - | mJ |
| Turn-off delay time | $t_{d(off)}$ | | - | 230 | - | ns |
| Fall time | t_f | | - | 70 | - | ns |
| Turn-off energy | E_{off} | | - | 0.8 | - | mJ |

Electrical Characteristics of the DIODE ($T_j = 25^\circ \text{C}$ unless otherwise specified)

| Parameter | Symbol | Conditions | Min. | Typ. | Max. | Unit |
|--------------------------|----------|---|------|------|------|------|
| Dynamic | | | | | | |
| Diode Forward Voltage | V_{FM} | $I_F = 40\text{A}$ | - | 2.6 | - | V |
| Reverse Recovery Time | T_{rr} | $I_F = 40\text{A},$ $V_R = 600\text{V},$ $di/dt = 400\text{A}/\mu\text{s},$ | - | 250 | - | ns |
| Reverse Recovery Current | I_{rr} | | - | 15 | - | A |
| Reverse Recovery Charge | Q_{rr} | | - | 600 | - | nC |

Fig. 1 FBSOA characteristics

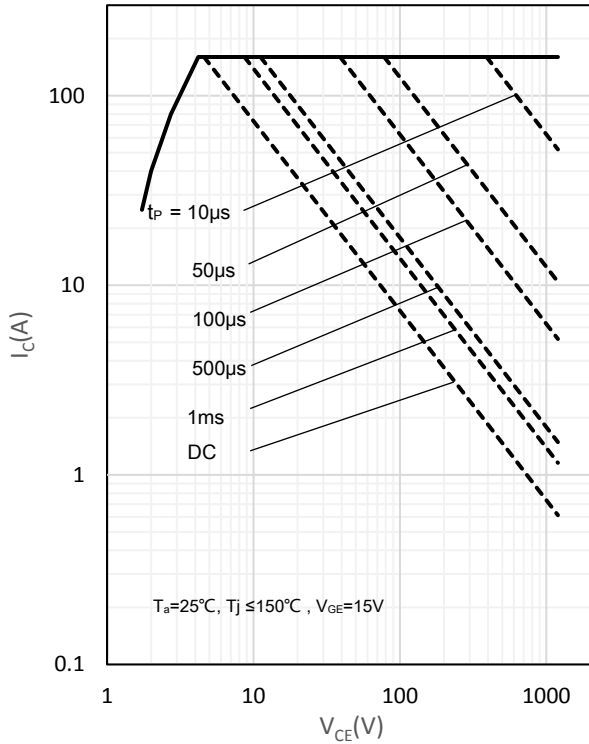

Fig. 2 Load Current vs. Frequency

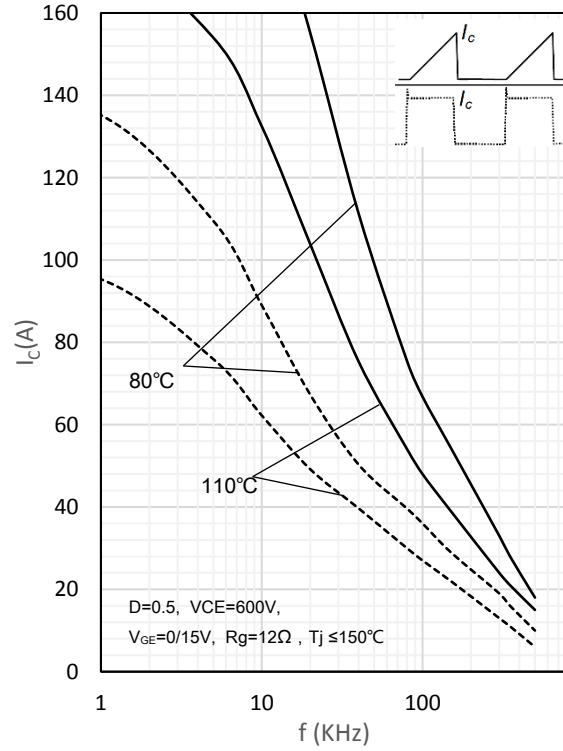

Fig. 3 Power dissipation as a function of T_c

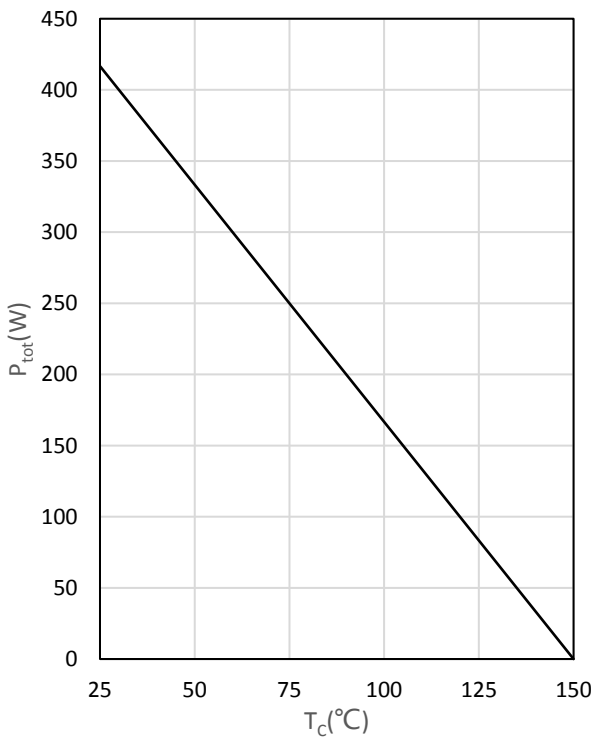

Fig. 4 Short circuit time and current vs. V_{GE}

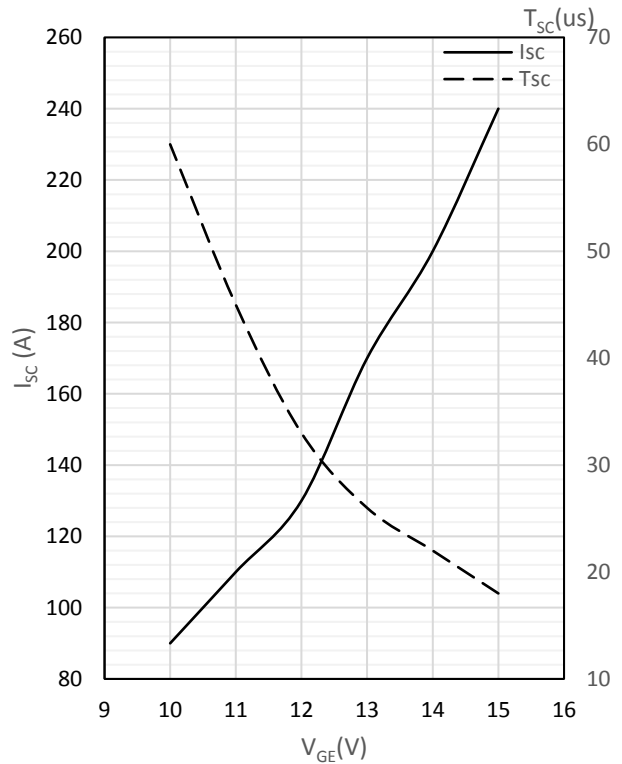

Fig. 5 Output characteristics

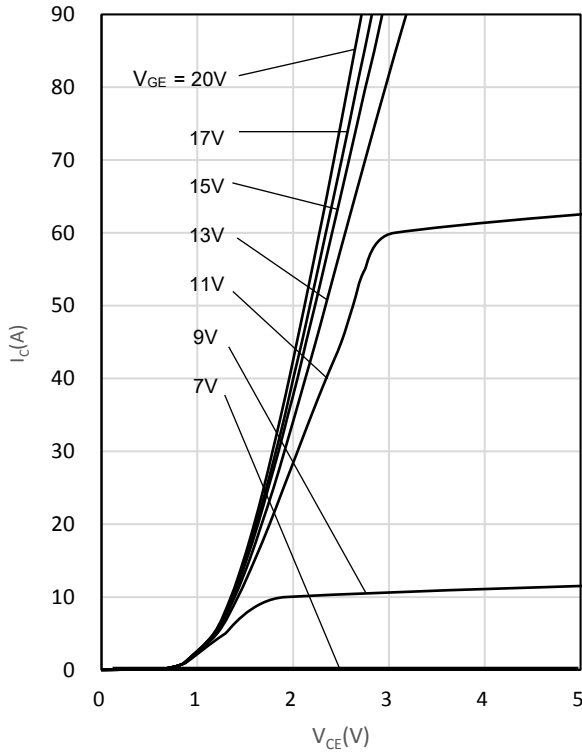

Fig. 6 Saturation voltage characteristics

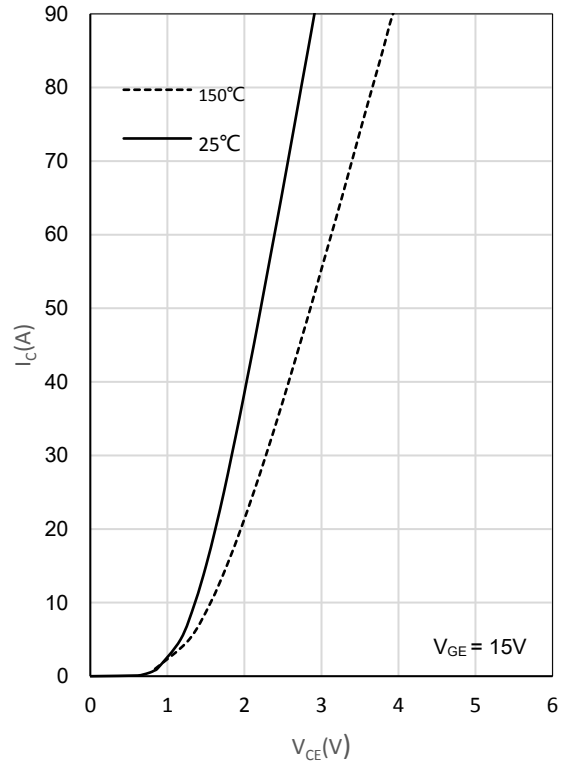

Fig. 7 Switching times vs. gate resistor

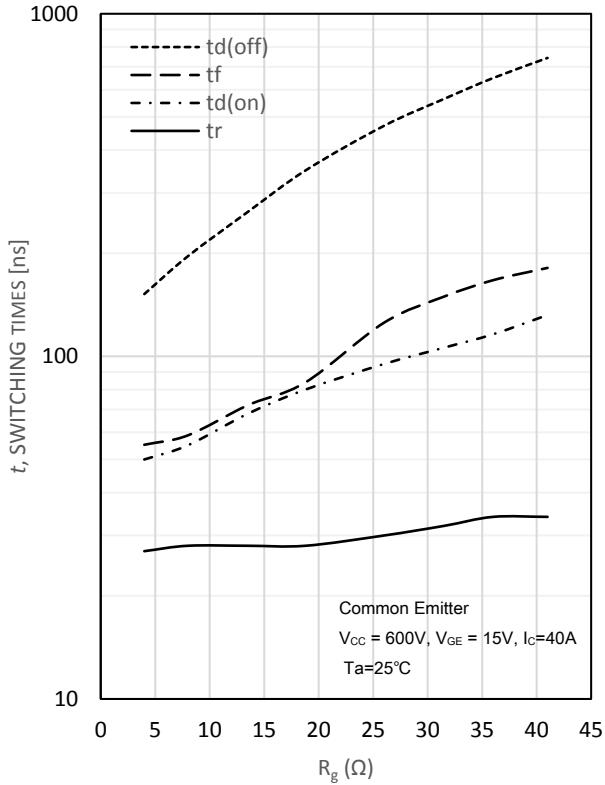

Fig. 8 Switching times vs. collector current

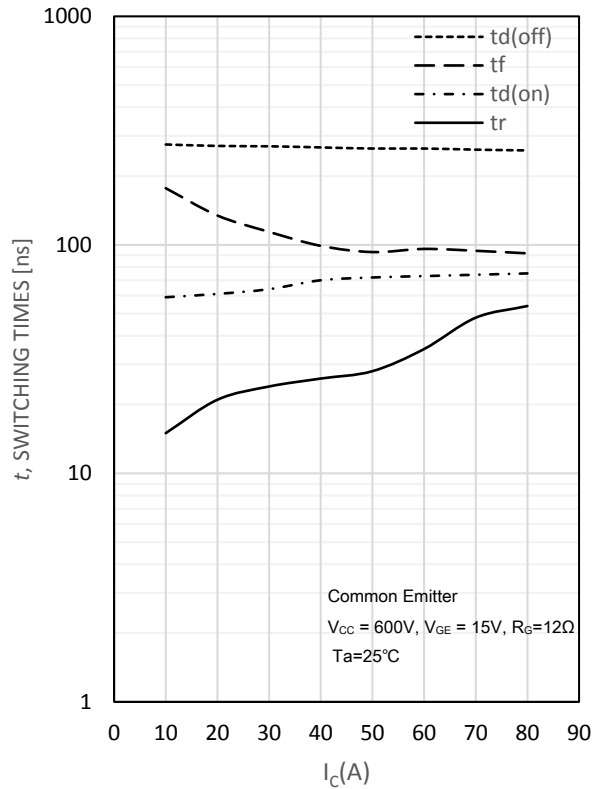

Fig. 9 Switching loss vs. gate resistor

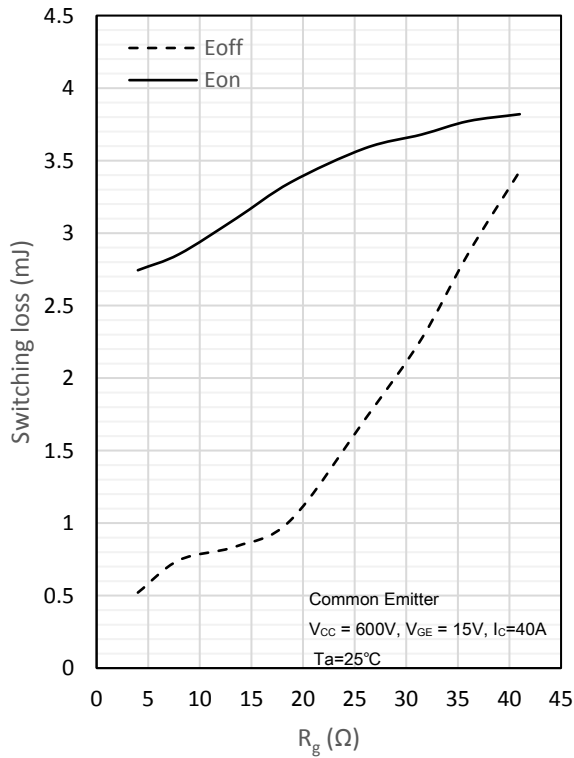

Fig. 10 Switching loss vs. collector current

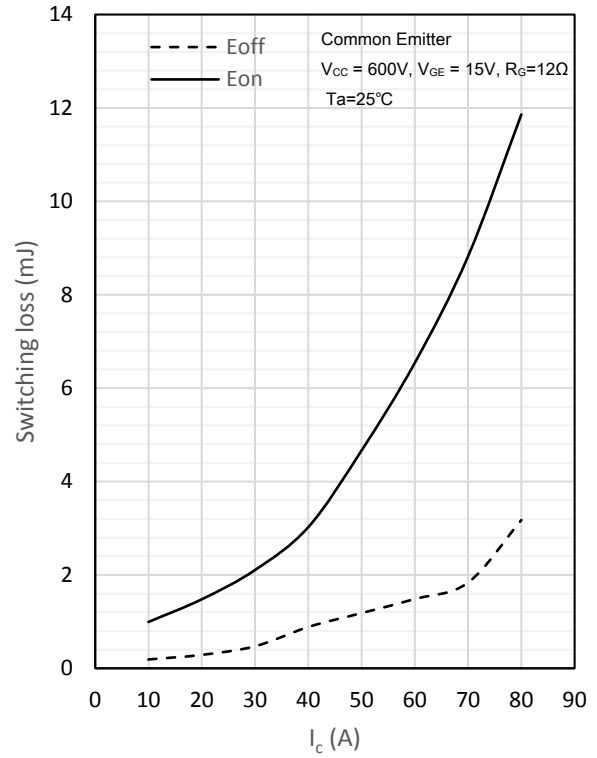

Fig. 11 Gate charge characteristics

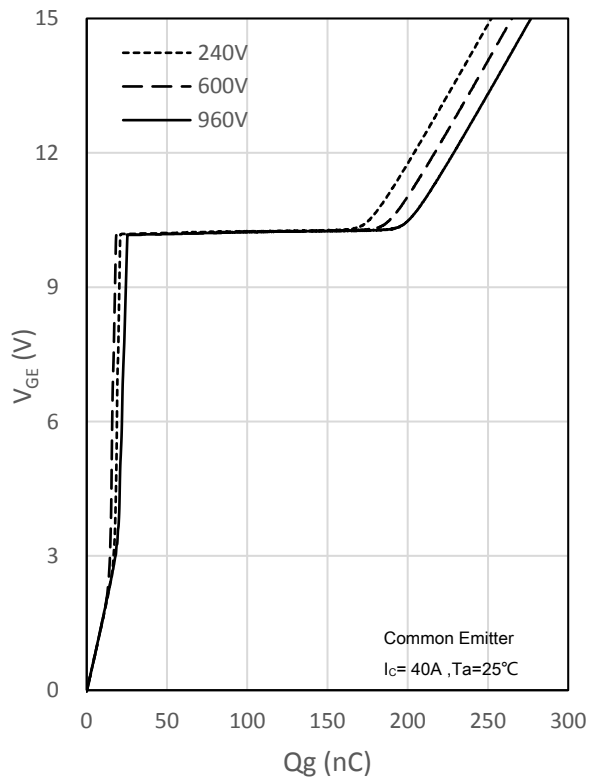
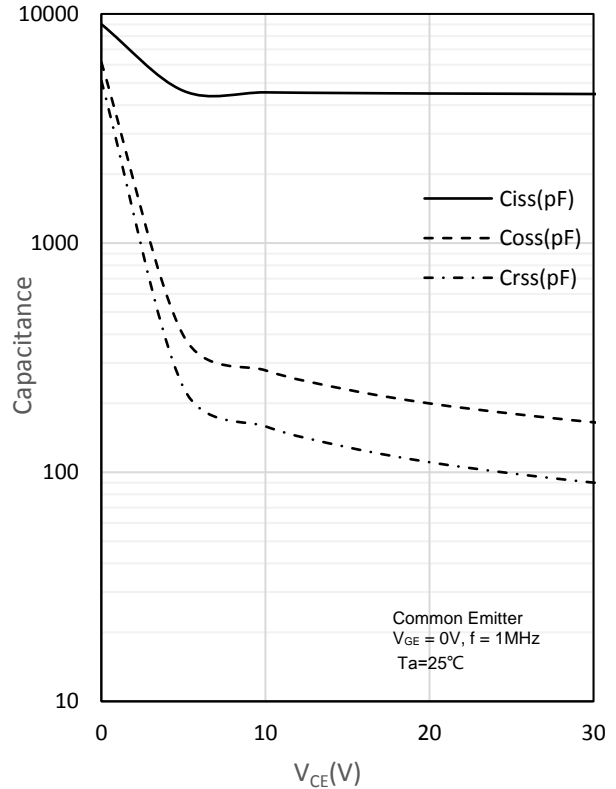
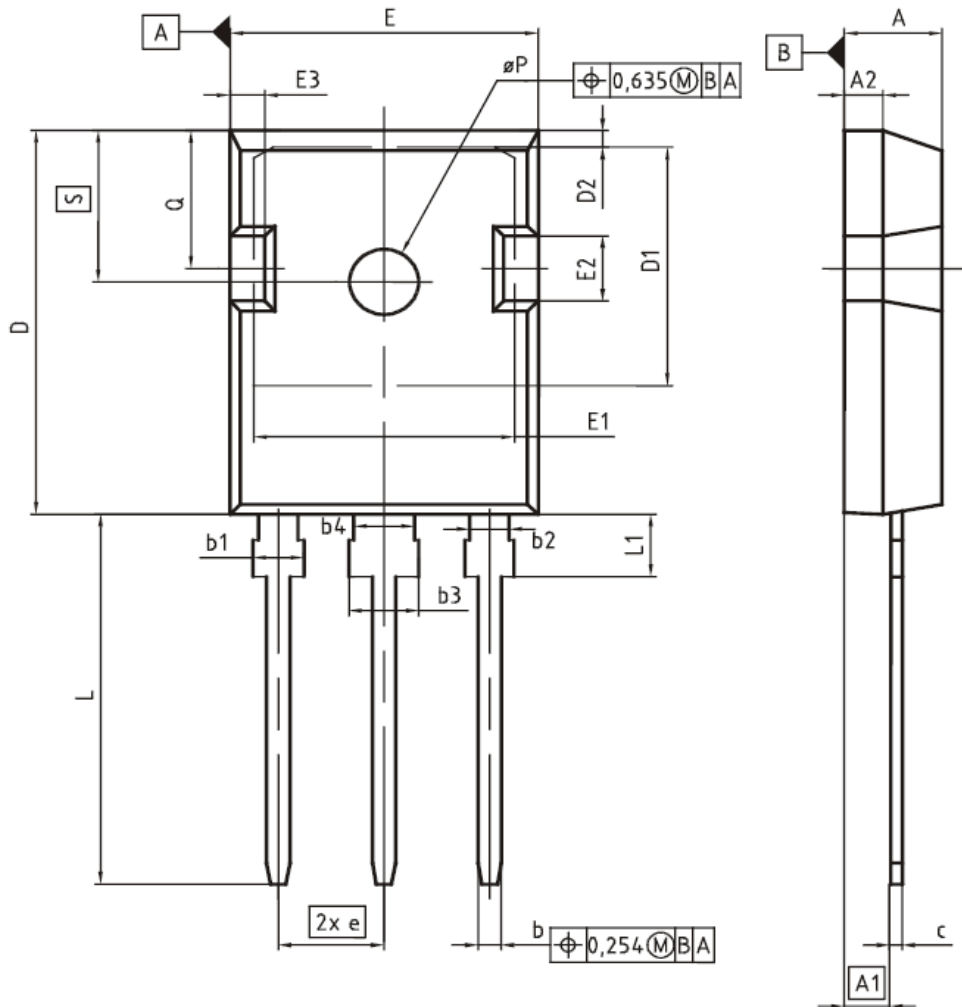

Fig. 12 Capacitance characteristics



PG-TO247-3



| DIM | MILLIMETERS | | INCHES | |
|-----|-------------|-------|-------------|-------|
| | MIN | MAX | MIN | MAX |
| A | 4.83 | 5.21 | 0.190 | 0.205 |
| A1 | 2.27 | 2.54 | 0.089 | 0.100 |
| A2 | 1.85 | 2.16 | 0.073 | 0.085 |
| b | 1.07 | 1.33 | 0.042 | 0.052 |
| b1 | 1.90 | 2.41 | 0.075 | 0.095 |
| b2 | 1.90 | 2.16 | 0.075 | 0.085 |
| b3 | 2.87 | 3.38 | 0.113 | 0.133 |
| b4 | 2.87 | 3.13 | 0.113 | 0.123 |
| c | 0.55 | 0.68 | 0.022 | 0.027 |
| D | 20.80 | 21.10 | 0.819 | 0.831 |
| D1 | 16.25 | 17.65 | 0.640 | 0.695 |
| D2 | 0.95 | 1.35 | 0.037 | 0.053 |
| E | 15.70 | 16.13 | 0.618 | 0.635 |
| E1 | 13.10 | 14.15 | 0.516 | 0.557 |
| E2 | 3.68 | 5.10 | 0.145 | 0.201 |
| E3 | 1.00 | 2.60 | 0.039 | 0.102 |
| e | 5.44 (BSC) | | 0.214 (BSC) | |
| N | 3 | | 3 | |
| L | 19.80 | 20.32 | 0.780 | 0.800 |
| L1 | 4.10 | 4.47 | 0.161 | 0.176 |
| øP | 3.50 | 3.70 | 0.138 | 0.146 |
| Q | 5.49 | 6.00 | 0.216 | 0.236 |
| S | 6.04 | 6.30 | 0.238 | 0.248 |